

# Manitowoc Crane Group

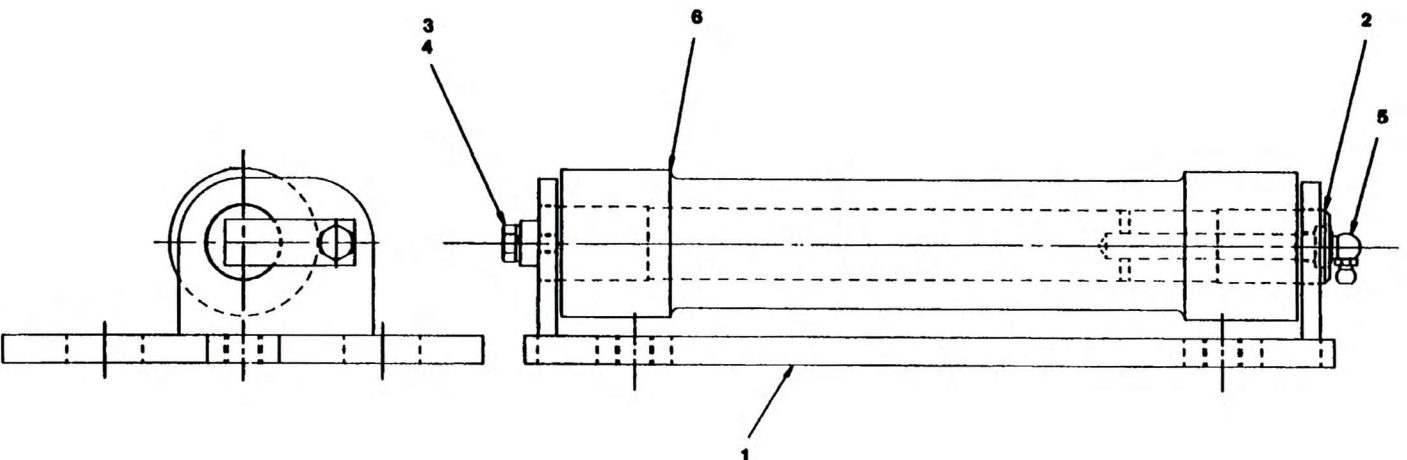

2141900102

(SHEET 1 OF 1)

Page 56